



Key Features

- Max. 2M (1920 x 1080) resolution
- H.264, MJPEG dual codec, Multiple streaming
- WDR (120dB), Defog
- Motion detection, Audio Detection, Face Detection with Metadata, Tampering, Virtual line, Enter/Exit, (Dis)Appear
- micro SD/SDHC/SDXC memory slot, Multi-crop streaming
- Extremely discreet design

Dimensions

Unit : mm (inch)

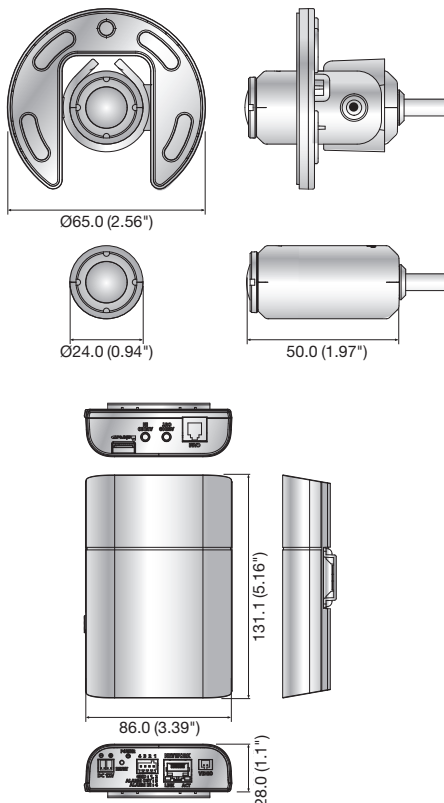

SNB-6011B

VIDEO	
Imaging Device	1/2.8" 2.38M CMOS
Total Pixels	1,952(H) x 1,116(V)
Effective Pixels	1,944(H) x 1,104(V)
Scanning System	Progressive
Min. Illumination	Color : 0.3Lux (1/30sec, F2.5, 50IRE)
Video Output	CVBS : 1.0Vpp / 75Ω composite, 720 x 480(N), 720 x 576(P), for installation DIP connector type
LENS	
Focal length	2.4mm pinhole
Max. Aperture ratio	F2.0
Angular Field of View	H : 134.3° / V : 70.9°
Min. Object Distance	0.3m (0.98ft)
Mount Type	RJ-12 connected with main unit
OPERATIONAL	
Camera Title	Off / On (Displayed up to 45 characters)
Day & Night	Auto (Electrical) / Color / B/W / Schedule
Backlight Compensation	Off / BLC / WDR
Wide Dynamic Range	120dB
Contrast Enhancement	SSDR (Samsung Super Dynamic Range) (Off / On)
Digital Noise Reduction	SSNR III (2D+3D noise filter) (Off / On)
Digital Image Stabilization	Off / On
Defog	Off / Auto / Manual
Motion Detection	Off / On (4ea 4 points polygonal zone)
Privacy Masking	Off / On (32 zones with 4 points of polygonal)
Gain Control	Off / Low / Middle / High
White Balance	ATW / AWC / Manual / Indoor / Outdoor
Electronic Shutter Speed	Minimum / Maximum / Anti flicker (2 ~ 1/12,000sec)
Flip / Mirror	Off / On
Intelligent Video Analytics	Tampering, Virtual line, Enter / Exit, (Dis)Appear, Audio detection, Face detection with metadata
Alarm I/O	Input 1ea / Output 1ea
Alarm Triggers	Motion detection, Alarm input, Video analytics, Network disconnection, Audio detection
Alarm Events	File upload via FTP and E-mail, Notification via E-mail, Local storage (SD/SDHC/SDXC) or NAS recording at Event (Alarm triggers), External output
NETWORK	
Ethernet	RJ-45 (10/100BASE-T)
Video Compression Format	H.264 (MPEG-4 part 10/AVC), MJPEG
Resolution	1920 x 1080, 1280 x 1024, 1280 x 960, 1280 x 720, 1024 x 768, 800 x 600, 800 x 450, 640 x 480, 640 x 360, 320 x 240, 320 x 180
Max. Framerate	H.264 : Max. 30fps at all resolutions MJPEG : 1920 x 1080, 1280 x 1024, 1280 x 960, 1280 x 720, 1024 x 768 : Max. 15fps 800 x 600, 800 x 450, 640 x 480, 640 x 360, 320 x 240, 320 x 180 : Max. 30fps
Video Quality Adjustment	H.264 : Compression level, Target bitrate level control, MJPEG : Quality level control
Bitrate Control Method	H.264 : CBR or VBR, MJPEG : VBR
Streaming Capability	Multiple streaming (Up to 10 profiles)
Audio In	Selectable (Mic in / Line in), Supply voltage : 2.5V DC (4mA), Input impedance : approx. 2K Ohm
Audio Out	Line out (3.5mm stereo mini jack), Max output level : 1 Vrms
Audio Compression Format	G.711 u-law/G.726 selectable, G.726 (ADPCM) 8KHz, G.711 8KHz G.726 : 16Kbps, 24Kbps, 32Kbps, 40Kbps
Audio Communication	Bi-directional audio (2-way)
IP	IPv4, IPv6
Protocol	TTCp/IP, UDP/IP, RTP(UDP), RTP(TCP), RTCP, RTSP, NTP, HTTP, HTTPS, SSL, DHCP, PPPoE, FTP, SMTP, ICMP, IGMP, SNMPv1/v2c/v3(MIB-2), ARP, DNS, DDNS, QoS, PIM-SM, UPnP, Bonjour
Security	HTTPS(SSL) login authentication, Digest login authentication IP address filtering, User access log, 802.1x authentication
Streaming Method	Unicast / Multicast
Max. User Access	15 users at unicast mode
Edge Storage	micro SD/SDHC/SDXC - motion Images recorded in the SD/SDHC/SDXC memory card can be downloaded. NAS (Network Attached Storage)
Application Programming Interface	ONVIF profile S, HTTP API (SUNAPI) 2.0, SVNP 1.2
Webpage Language	English, French, German, Spanish, Italian, Chinese, Korean, Russian, Japanese, Swedish, Danish, Portuguese, Turkish, Polish, Czech, Romanian, Serbian, Dutch, Croatian, Hungarian, Greek, Finnish, Norwegian
Web Viewer	Supported OS : Windows 7, 8, 10, Mac OS X 10.8, 10.9, 10.10, 10.11 Supported Browser : MS Explore 11, Mozilla Firefox 43, Apple Safari 9 * Mac OS X only
Central Management Software	Smart Viewer, SSM
ENVIRONMENTAL	
Operating Temperature / Humidity	-10°C ~ +55°C (+14°F ~ +131°F) / Less than 90% RH
Storage Temperature / Humidity	-30°C ~ +60°C (-22°F ~ +140°F) / Less than 90% RH
ELECTRICAL	
Input Voltage / Current	PoE (IEEE802.3af), 12V DC
Power Consumption	PoE : Max. 7.5W, 12V DC : Max. 6.5W
MECHANICAL	
Color / Material	Camera header : Black / Plastic, Main unit : Ivory / Plastic
Dimensions (WxHxD)	Camera header : $\varnothing 24.0$ x 50.0mm ($\varnothing 0.94$ " x 1.97") Main unit : 131.1 x 28.0 x 86.0 (5.16" x 1.1" x 3.39")
Weight	Camera unit (Include 1.5m cable) : 80g (0.18 lb), Main unit : 255g (0.56 lb)

* Data recorded on an SD memory card may be lost or damaged by data access during power-off, mechanical shock, memory card detachment, or other operations. Data loss or damage can also occur when a memory card reaches end of life, which varies according to operational conditions. No guarantee is given against damage (including passive damage).

* The latest product information / specification can be found at www.samsungsecurity.com